

CORNELL PUMP COMPANY  
**MINING**



Preferred Australian Mining Supplier &  
Cornell Pump Partner

**SOURCE**  
Bespoke Pumping Solutions

# PUMPS FOR THE MINING INDUSTRY

## WHAT SETS CORNELL MINING PUMPS APART

Cornell Pump has been producing robust, high-efficiency pumps since 1946, and our innovative pumps have provided unmatched value.

### A WIDE VARIETY OF SIZES AND CONFIGURATIONS

Cornell Pump offers models of various sizes ranging from 2" to 30". Each model has different configuration options, such as frame and engine mount options, and additional features like Run-Dry™ and Redi-Prime® are also available.

### OUTSTANDING EFFICIENCIES

We utilize our expertise and know-how to create proven designs with exceptionally high efficiencies that surpass most pumps available in the market. In fact, our mining series boasts up to 85% efficiency.

### CYCLOSEAL

A new sealing system prevents pump leaks on mining sites without requiring flush water, avoiding contamination.

### ROBUST CONSTRUCTION

Cornell pumps are made with solid and durable materials carefully chosen for each pump's specific purpose. Thicker shafts, heavier casting walls, and fully-machined impellers are among the features that make Cornell pumps more rugged and long-lasting than other pumps.

## Compare the Ruggedness of Cornell Series Pumps

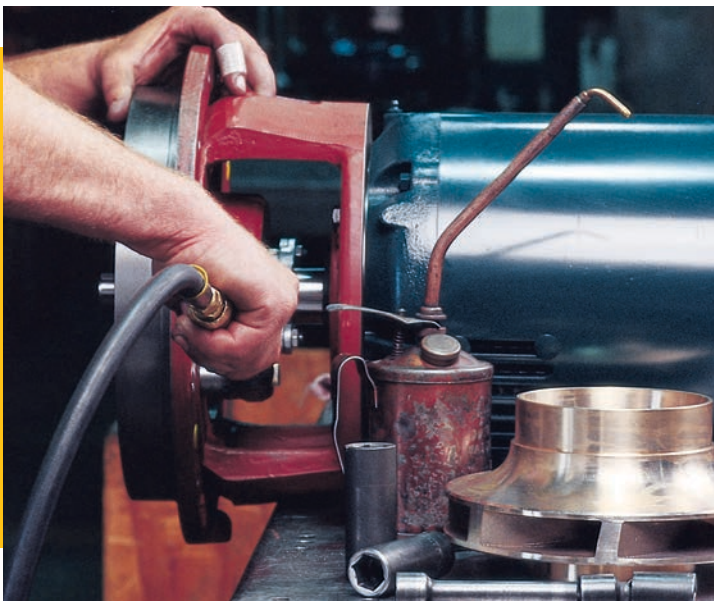
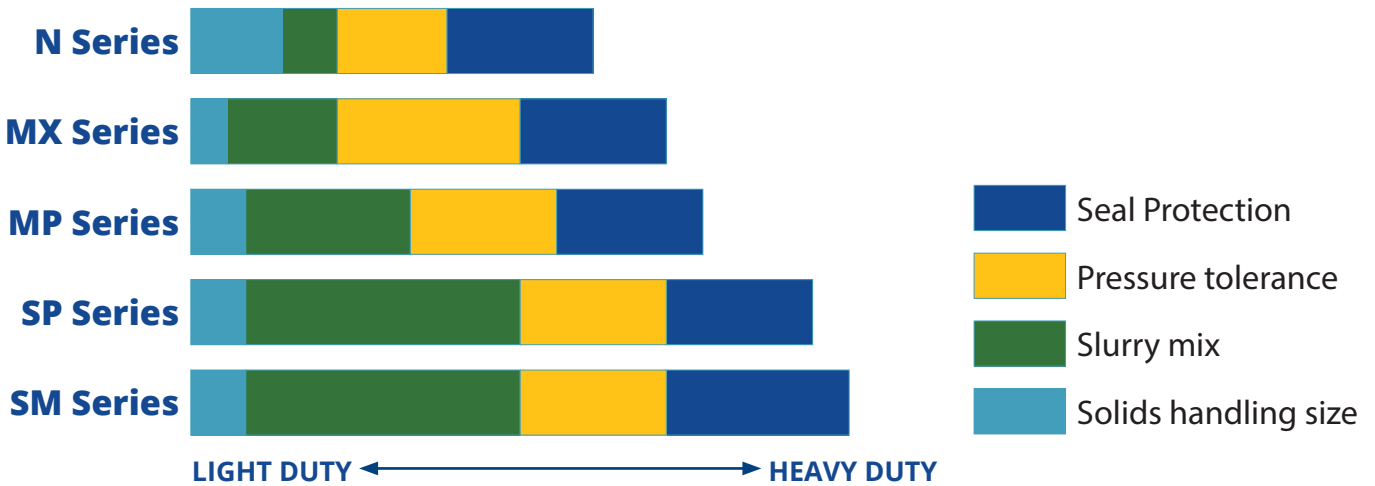

## QUALITY ASSURANCE

Cornell Pump proudly maintains its ISO 9001:2015 certification that validates Cornell complies with all necessary processes to meet customer requirements.

The elements associated with ISO 9001:2015 certification include such areas as contract review, design and development, production, purchasing, quality control, and service.



*Proudly designed and manufactured in Oregon, United States of America.*

# PUMPS FOR THE MINING INDUSTRY



## SP SLURRY PUMP GOING STRONG AFTER YEARS IN SERVICE

In May 2012, an Australian sand quarry installed a Cornell 6SP rubber-lined slurry pump. It has been operating flawlessly and has never leaked. The pump processes approximately 50 tons of material per hour, fed as a slurry and separated in a cyclone separator to extract sand. The operation runs five days a week, about nine hours daily, and the slurry contains 30% solids.

The Cornell 6SP rubber-lined slurry pump has operated flawlessly in the sand quarry for over nine years. The pump runs 9 hours daily, five days a week, and handles a slurry of around 30% solids. Since its installation, the pump has been started and stopped 5,800 times without any issues. While the impeller and liner wear parts have been replaced, the Cycloseal sealing seal system has never required replacement and has not leaked.

*For more information about this and other application stories, visit [cornellpump.com](http://cornellpump.com)*



## N-SERIES SOLIDS HANDLING PUMPS

Discharge sizes up to 24", flows up to 38,000 GPM, and solids up to 10.2".

**IMPELLER CHOICES:** choose from the Delta style impeller for heavy sludge, two and three-port enclosed impellers for large solids, and three or four-bladed, semi-open impeller with cutting action for the worst slurries/solids.

### PERFORMANCE

PERFORMANCE	
DISCHARGE SIZE RANGE	3" TO 24"
MAX SOLIDS HANDLING	10.2"
MAX FLOW	38,000 GPM
MAX HEAD	500'

### MATERIALS OF CONSTRUCTION

- Ductile or cast iron pump casings
- Some models available in CD4MCu
- Ductile, cast iron, or CD4MCu impellers
- Stressproof or heat treated steel shafts (stainless on CD4MCu)
- SAE 1144 stressproof steel
- H20HT wear rings and shaft sleeve available

### FEATURES CONTINUED

- Cycloseal® grit removal system
- High-efficiency design
- Run-Dry Option
- Redi-Prime Option
- Excellent NPSHr
- Ruggedness and durability
- Two-year warranty
- Minimum 3 inch solids handling

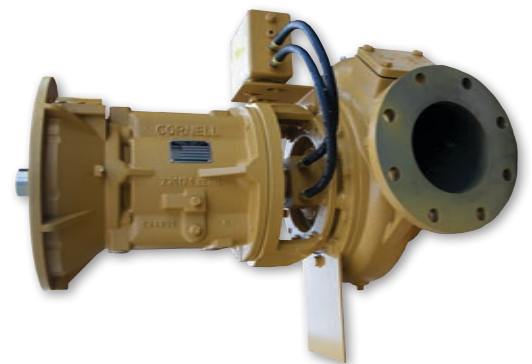

# PUMPS FOR THE MINING INDUSTRY



## HIGH HEAD PUMPS

Cornell's MX high head mining pump series provide heads up to 825', long service life, and industry-leading efficiency.

### PERFORMANCE

DISCHARGE SIZE RANGE	2" TO 8"
MAX SOLIDS HANDLING	2.38"
MAX FLOW	8,000 GPM
MAX HEAD	825'

### MATERIALS OF CONSTRUCTION

- Ductile iron casings
- 17-4PH stainless steel shafts
- CA6NM impellers
- Optional hardened wear ring and shaft sleeves.

### FEATURES

- Cycloseal® grit removal system
- High-efficiency design
- Run-Dry Option
- Redi-Prime Option
- High operating pressures
- Two-year warranty



## PUMPS FOR COARSE ABRASIVES

MP Series pumps are unlined slurry pumps designed for coarse abrasives and solids up to 3". The MP series offers exceptional wear resistance for reduced maintenance and long life in harsh environments.

**ADJUSTABLE WEAR PLATE:** to maintain lost efficiency while in service.

### PERFORMANCE

DISCHARGE SIZE RANGE	2" TO 8"
MAX SOLIDS HANDLING	3"
MAX FLOW	9,000 GPM
MAX HEAD	625'

### MATERIALS OF CONSTRUCTION

- Available in a ductile iron, chrome iron, or hybrid construction
- 17-4PH stainless steel shafts
- Hardness rating > 650BHN

### FEATURES

- Cycloseal® grit removal system
- High-efficiency design
- Run-Dry Option
- Redi-Prime Option
- Heavy-duty construction for aggressive applications
- Replaceable wear plates
- Two-year warranty



# PUMPS FOR THE MINING INDUSTRY



## SM SERIES HEAVY DUTY SLURRY PUMPS

The SM Series of pumps from Cornell is designed to handle a wide range of slurry applications and are especially effective for series pumping. These pumps are robust and durable with their unlined high chrome white iron wet ends. They are equipped with Cycloguard® and Cycloseal® innovations that extend their seal life and keep solids away from the seal area for reduced wear. The pumps are designed to operate at a maximum working pressure of 600 PSI.

PERFORMANCE	
DISCHARGE SIZE RANGE	2" TO 10"
MAX SOLIDS HANDLING	4"
MAX FLOW	12,000 GPM
MAX HEAD	330'

### MATERIALS OF CONSTRUCTION

- Chrome Iron Impeller, volute, volute casing, wear palte, backplate, and expeller
- 4140 Steel Shaft
- 420 Stainless Shaft Sleeve
- Ductile Iron suction cover

### FEATURES

- Back pullout design to simplify maintenance
- 600 PSI rated pressure
- CycloGuard™ to reduce inlet recirculation
- Infinitely variable volute and discharge position
- Axially adjustable suction wear plate = no frame adjustment needed or realignment of belts/piping
- Available in any pipe flange standard
- Standard CycloSeal® – no flush water required

### FEATURES CONTINUED

- Other shaft seal arrangements available
- Grease or oil lubricated bearing frame
- High-capacity bearings available
- Ideal for series/multistage pumping applications
- Handles high solids concentrations

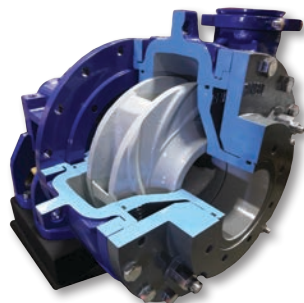

## PUMPS FOR SLURRY APPLICATIONS

SP-SERIES PUMPS pass up to 4.1" solids. Rubber or metal lined, handles pH from 1 to 14 depending on configuration. Capable of pumping slurries that are up to 40% solids by volume.

PERFORMANCE	
DISCHARGE SIZE RANGE	2" TO 12"
MAX SOLIDS HANDLING	4.1"
MAX FLOW	18,000 GPM
MAX HEAD	290'

### MATERIALS OF CONSTRUCTION

- Chrome iron impellers
- Ductile iron volute casings
- Volute lining either chrome iron or rubber
- 4140 steel shafts
- Ductile iron bearing housing and cast iron bearing frames

### FEATURES

- Cycloseal® grit removal system
- Enclosed impeller for higher efficiency
- Run-Dry Option
- Redi-Prime Option
- Superior abrasive and corrosive wear life
- No seal flush, vent line or lubrication required
- Various materials of construction
- Ruggedness and durability
- Two-year warranty



# CORNELL FEATURES & BENEFITS



## FEATURES



CLEAN STEEL



BRINELL HARDNESS  
UP TO 285



INDUSTRY LEADING  
TWO YEAR WARRANTY

## CD4MCu OPTIONS

CD4MCu is duplex stainless steel that uses a two-phase metallurgy process, different from the single-phase metallurgy process found in common stainless steel grades like 316. This process combines the corrosion resistance of 300-series stainless steel with the strength and hardness of 400-series stainless steel. This results in stainless steel with equivalent or superior corrosion resistance to 316 SS but with twice the yield strength. CD4MCu allows pumps to be used in more abrasive applications with enhanced resistance to corrosive cracking and pitting. Cornell has made CD4MCu castings available in-store for 23 of its most popular pump models, which reduces production time. We can now build a CD4MCu pump in about one to two weeks.

## CD4MCu BENEFITS

- Corrosion and pitting resistance
- Higher strength than standard grades of stainless steel
- Improved ductility and weldability
- Better resistance to embrittlement

## CORNELL PUMP BENEFITS

- Fully automated priming and self-priming, dry-run pumps
- Handles air/liquid mixtures with ease
- Patented Cycloseal®, Redi-Prime®, and Run-Dry™ options
- Cornell Competitive Advantage: Patented Engineering Features

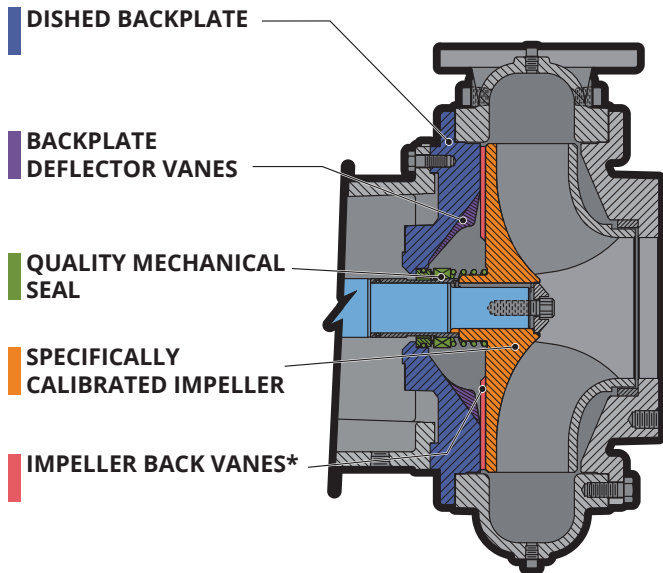

## CYCLOSEAL® SAVES YOUR FROM FLUSHING AWAY MONEY!

Each pump requiring flush water can incur costs of \$6,000 or more. For instance, a typical 6" pump uses 3 gallons per minute, which may not seem like much. Still, it adds up to over 1.57 million gallons (5,950 m<sup>3</sup>) annually. Larger pumps, such as 8" and 16" to 24" pumps, consume even more water, with some using 8 million gallons (30,300 m<sup>3</sup>) or more per year. When you factor in multiple pumps per location and several locations per organization, the amount of water utilized just for seals is HUGE.

Cycloseal® provides an answer:

- REQUIRES NO FLUSH WATER.
- Uses inexpensive and easy-to-change type 1 or 2 mechanical seals.
- Saves \$6,000 or more in flush costs.
- More environmentally friendly alternative.
- Plus Cornell Pumps are high-efficiency and can save your operation even more money.

# PUMP PRIMERS



## STX/STL/STH SERIES PUMPS

The STX/STL/STH Series of self-priming pumps are known for their high efficiency and durability. With patented-Cycloseal® backplate technology, they provide robust and energy-efficient pumping, with a maximum head of up to 253' and efficiencies of up to 68%. They can handle solids generated in mine dewatering, making them popular for trash-pumping applications.

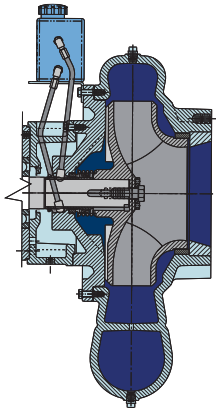

## RUN-DRY™

Run your pump dry without expensive water systems and mechanical seal damage. Cornell's Run-Dry system consists of an auxiliary gland that provides containment for an application-specific lubricant present at the inside diameter of the mechanical seal faces. This lubricant prevents dry running of the seal faces while priming, re-priming, and on standby. The Run-Dry gland is connected to a lubricant reservoir via inlet and outlet lines oriented tangentially to the pump shaft.

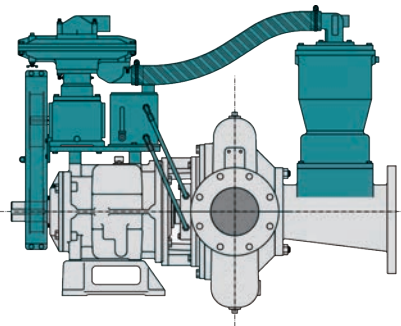

## REDI-PRIME®

Cornell's Redi-Prime pumps have oversized suctions that increase flow, decrease friction losses, and enhance suction lift. The priming system is environmentally friendly, featuring a positive sealing float box and a diaphragm vacuum pump that prevents water carry-over and contamination. The Redi-Prime system can be easily installed on most Cornell pumps, providing suction lifts of up to 28 feet, heads up to 800 feet, and flow rates surpassing 20,000 GPM.

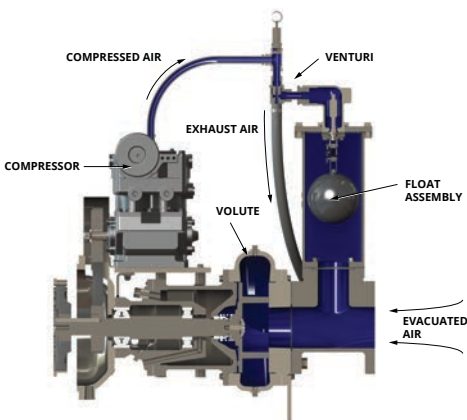

## VENTURI PRIME

The Cornell venturi prime system is cost-effective and compatible with any Cornell Pump that offers Redi-Prime® as an option. It uses a compressor powered by the pump shaft and lubricated by engine oil to blow air through the venturi, evacuating it from the suction line and pump casing.

Cornell's Venturi Prime System may take longer to prime than Redi-Prime, but it performs better in freezing temperatures and can be customized to meet specific requirements. It offers an economical solution without compromising on quality.

CORNELL PUMP COMPANY

# MARKET & PRODUCT LINE

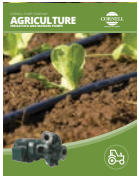

AGRICULTURE



FOOD PROCESS



INDUSTRIAL



MINING

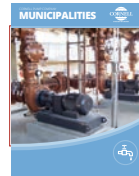

MUNICIPAL



WATER TRANSFER



REFRIGERATION

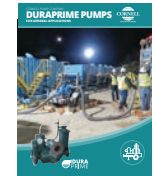

CONSTRUCTION

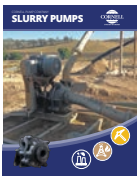

SLURRY

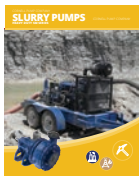

SLURRY SM

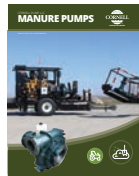

MANURE

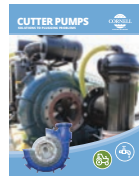

CUTTERS

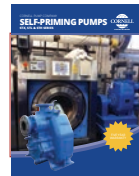

SELF PRIMING

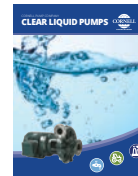

CLEAR LIQUIDS



MX SERIES

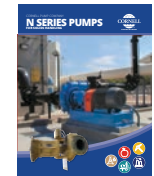

N SERIES

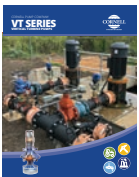

CYCLONE™

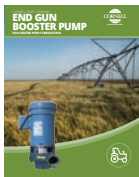

EDGE™



HYDRAULIC SUBS

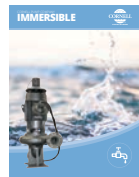

IMMERSIBLE



CD4MCU



RUN-DRY™



PRIMING SYSTEMS

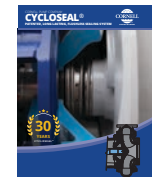

CYCLOSEAL®

Cycloseal® and Redi-Prime® are Registered Trademarks of Cornell Pump Company.

Cornell pumps and products are the subject of one or more of the following U.S. and foreign patents:

6,074,554; 6,036,434; 6,079,958; 6,309,169; 6,104,949.

23 - MI - BR - 001

**CORNELLPUMP.COM**  
©2023 CORNELL PUMP COMPANY



Cornell Pump Company  
Clackamas, Oregon, USA  
P: +1 (503) 653-0330  
F: +1 (503) 653-0338

**SOURCE**  
Bespoke Pumping Solutions



**Source Pumps PTY LTD**  
22 Peterpaul Way  
Truganina, VIC 3029  
sourcepumps.com.au  
sales@sourcepumps.com.au