

CORNELL PUMP COMPANY

MX SERIES

HIGH HEAD PUMPS



Preferred Australian Mining Supplier &
Cornell Pump Partner

SOURCE
Bespoke Pumping Solutions

MX SERIES



MX SERIES

Designed to handle high head applications while providing a long service life, the MX SERIES pumps have multi-vane, enclosed CA6NM impellers designed for **INDUSTRY LEADING EFFICIENCY OF UP TO 78%!**

- Heads to 800'
- Flows to 8,000 GPM
- Handles up to 2.38" solid
- Available in 2" to 8" models

FEATURES AND BENEFITS

CORNELL CYCLOSEAL® SEALING SYSTEM with tungsten carbide vs. silicon carbide seal and grit removal system.

HIGH STRENGTH STEEL SHAFT* and double angular contact thrust bearings** extend the operating range and reduce shaft breakage.

HIGH-EFFICIENCY DESIGN pumps more liquid using less energy for substantial savings over the pump's life.

3 OR 4 VANE-ENCLOSED IMPELLERS are dynamically balanced and designed to handle solids up to 2.38."

DUCTILE IRON CONSTRUCTION for increased durability and resistance to wear.

300-LB RATED DISCHARGE FLANGES and all iron frame construction for durability in harsh conditions.

CA6NM IMPELLER is standard on MX Series pumps.

IT WITHSTANDS HIGH OPERATING PRESSURES to achieve 600' to 800' TDH and flows up to 8,000 GPM.

OPTIONAL HARDENED WEAR RINGS on the impeller and volute provide added resistance to abrasive materials.

A TWO-YEAR WARRANTY is standard on all MX Series pumps.

** Either 17-4PH Stainless or high-strength tool steel, depending on the model.*

*** The 80126MX includes triple angular contact bearings.*



MX SERIES FAMILY CURVE

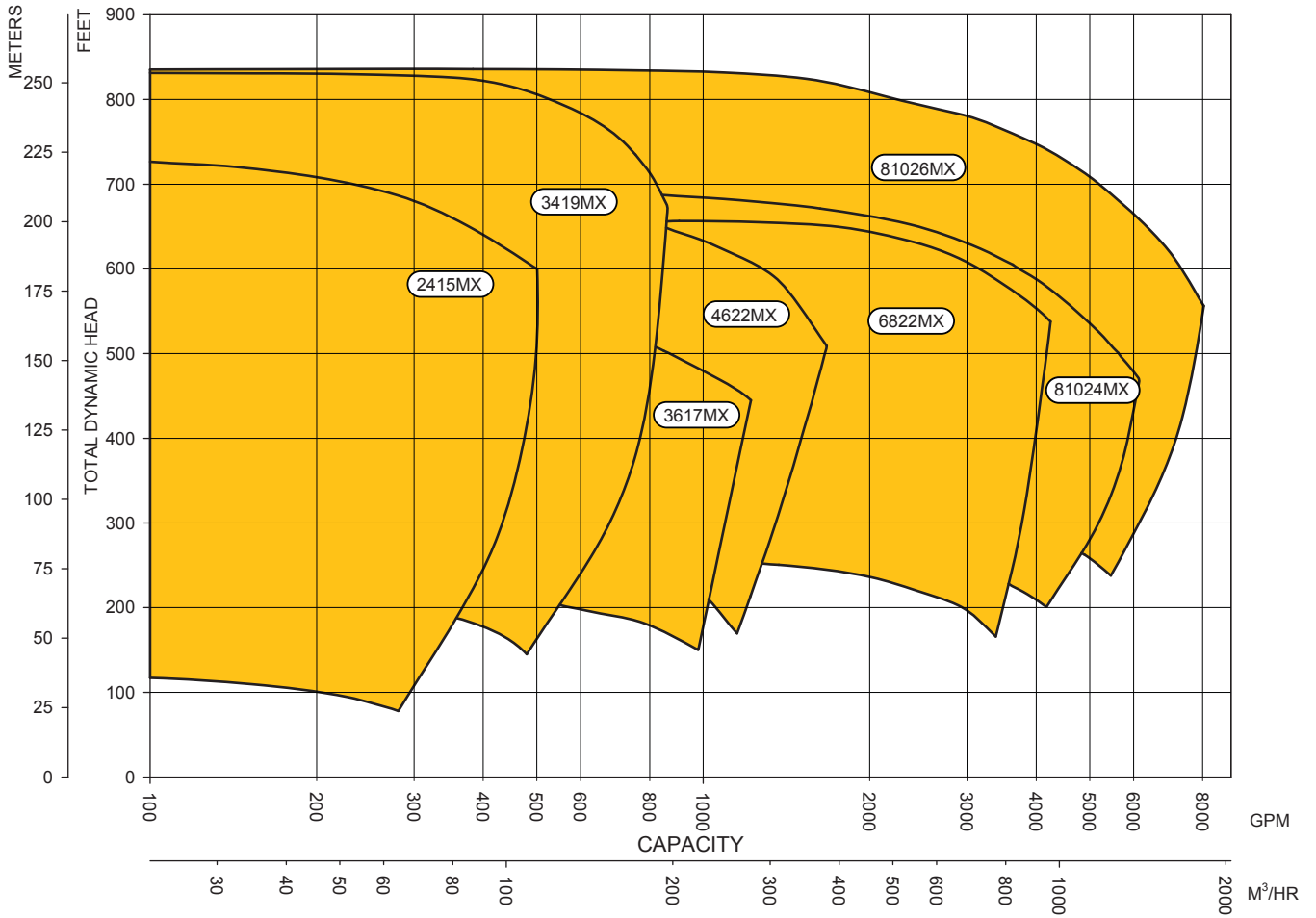

MX SERIES CURVES

2415MX

- Flow rates from 115 to 480 GPM (25 to 110 m³/h)
- Pressure to 350 PSI (2415 kPa)
- 50% efficient at Best Efficiency Point

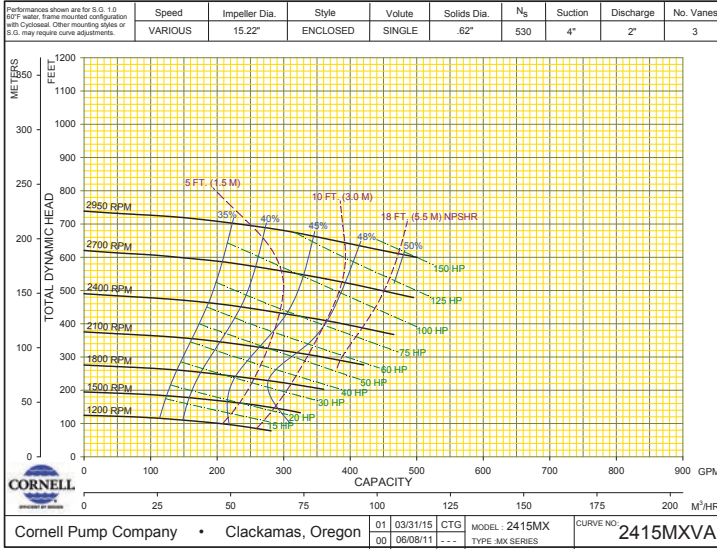

3419MX

- Flow rates from 170 to 800 GPM (40 to 180 m³/h)
- Pressure to 350 PSI (2415 kPa)
- 55% efficient at Best Efficiency Point

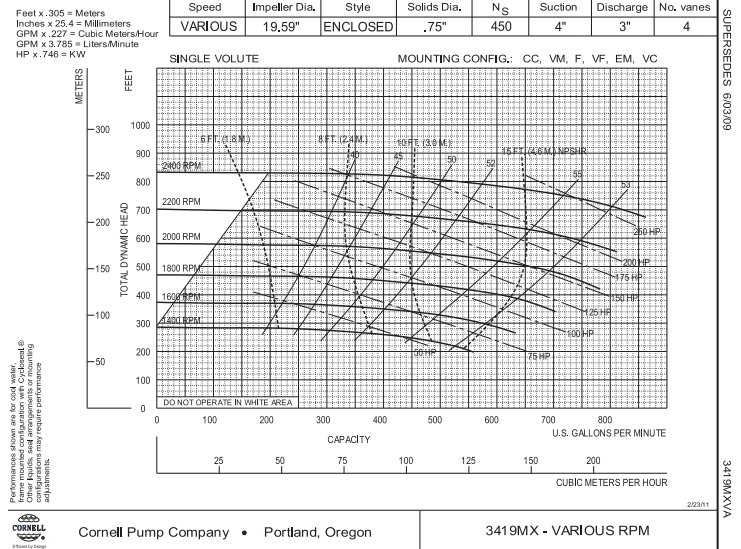

3617MX

- Flow rates from 230 to 1220 GPM (50 to 275 m³/h)
- Pressure to 250 PSI (1725 kPa)
- 67% efficient at Best Efficiency Point

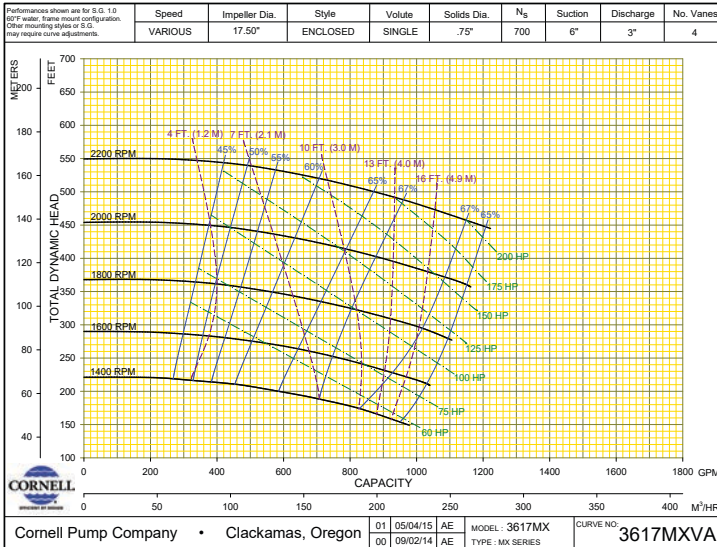

4622MX

- Flow rates from 390 to 1680 GPM (90 to 380 m³/h)
- Pressure to 440 PSI (3035 kPa)
- 65% efficient at Best Efficiency Point

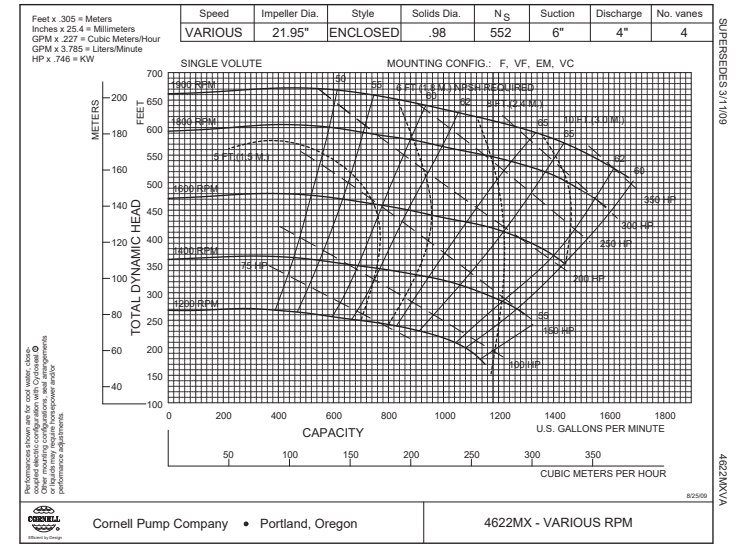

MX SERIES CURVES

6822MX

- Flow rates from 575 to 4150 GPM (130 to 945 m³/h)
- Pressure to 350 PSI (2415 kPa)
- 75% efficient at Best Efficiency Point

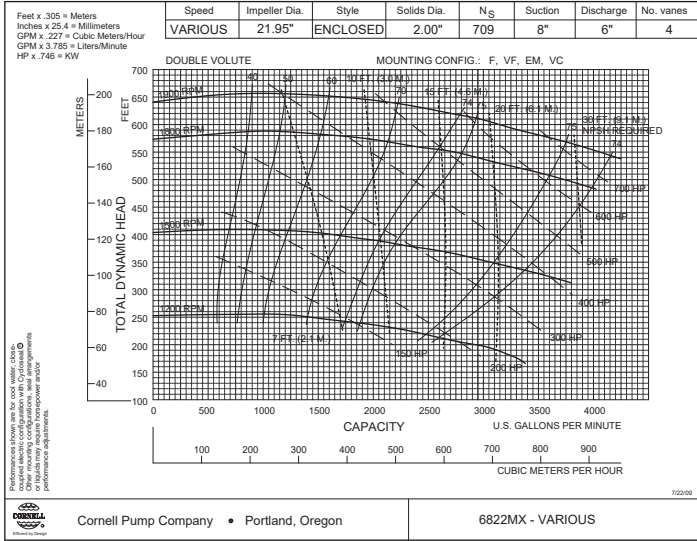

81024MX

- Flow rates from 1200 to 7150 GPM (275 to 1625 m³/h)
- Pressure to 340 PSI (2344 kPa)
- 73% efficient at Best Efficiency Point

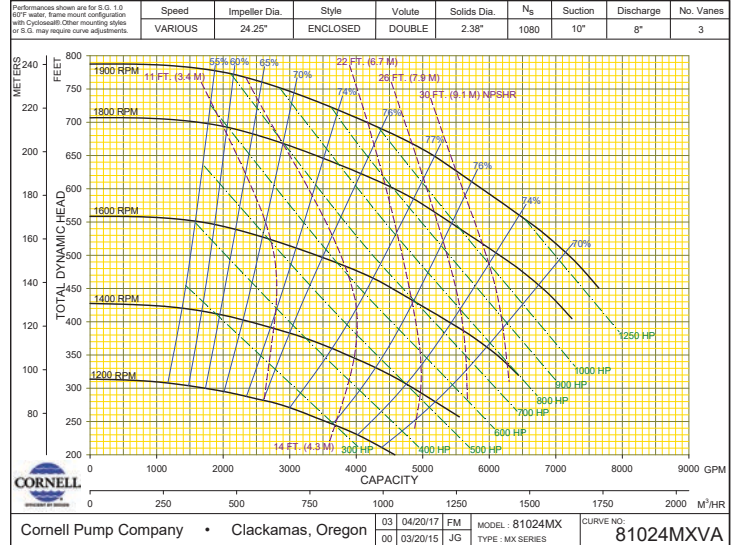

81026MX

- Flow rates from 1800 to 8000 GPM (410 to 8000 m³/h)
- Pressure to 475 PSI (3275 kPa)
- 78% efficient at Best Efficiency Point

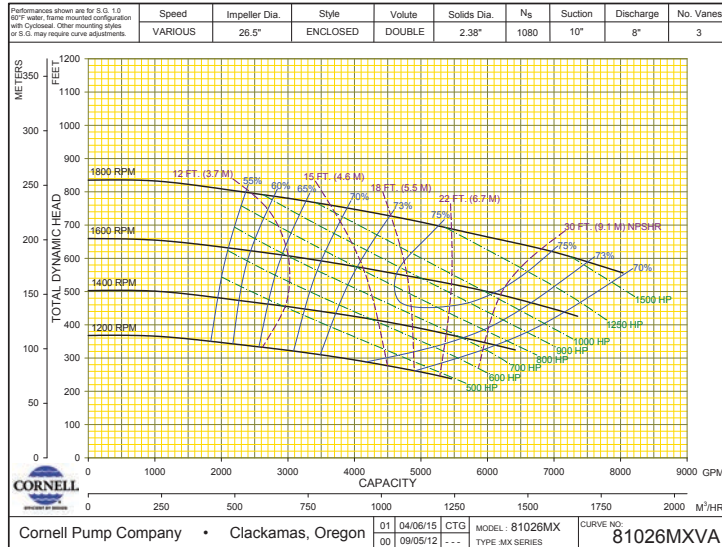

WE PUT OUR BEST IDEAS TO THE TEST

Cornell's state-of-the-art hydraulics laboratory is the testing ground for

all our pumps. We aim to provide the most efficient pumps when energy costs rise. Under the guidance of Registered Professional Engineers, our team of expert technicians conducts certified performance tests to determine the performance and NPSH required for specific design conditions with precision.



The research facility features an 80,000-gallon closed-loop system that allows us to conduct accurate low-pressure tests. The system can circulate up to 60,000 gallons of water per minute. All test motors are calibrated and adhere to the Hydraulic Institute Standards. We can test pumps up to 4,000 horsepower at various speeds. Upon request, we can perform additional tests.

ADDITIONAL OPTIONS

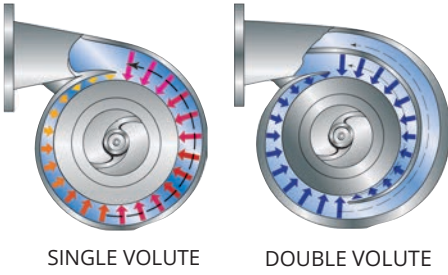

DOUBLE VOLUTE DESIGN

More than 30 years ago, Cornell was the first in the industry to introduce the double-volute system. This innovation effectively balances forces within the pump, reducing radial load, shaft deflection, and fatigue. Doing so eliminates shaft breakage and extends the service life of packing and mechanical seals, wear rings, and bearings while ensuring high hydraulic efficiency.

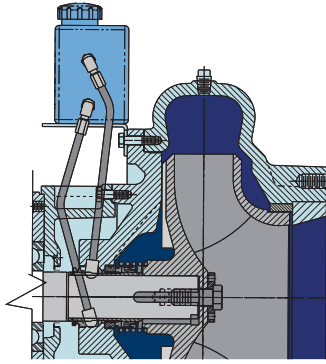

RUN-DRY™

Cornell has developed the Run-Dry system to prevent pump damage during dry operating conditions. This system features an auxiliary gland and oil reservoir that keeps seal faces lubricated during priming, re-priming, or standby operation. The gland is connected to a lubricant reservoir, allowing continuous circulation and cooling of the lubricant and seal faces. The Run-Dry system is ideal for applications where dry operation is possible.

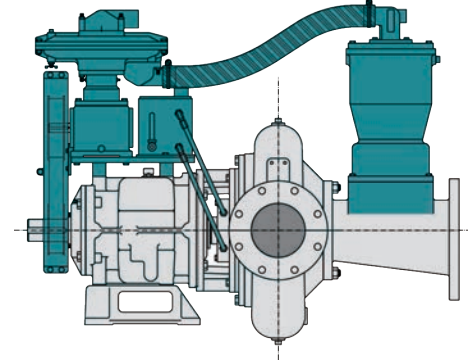

REDI-PRIME®

Cornell's Redi-Prime pumps have oversized suctions that increase flow, decrease friction losses, and enhance suction lift. The priming system is environmentally friendly, featuring a positive sealing float box and a diaphragm vacuum pump that prevents water carry-over and contamination. The Redi-Prime system can be easily installed on most Cornell pumps, providing suction lifts of up to 28 feet, heads up to 800 feet, and flow rates surpassing 20,000 GPM.



CD4MCu OPTIONS

CD4MCu is duplex stainless steel that uses a two-phase metallurgy process, different from the single-phase metallurgy process found in common stainless steel grades like 316. This process combines the corrosion resistance of 300-series stainless steel with the strength and hardness of 400-series stainless steel. This results in stainless steel with equivalent or superior corrosion resistance to 316 SS but with twice the yield strength. CD4MCu allows pumps to be used in more abrasive applications with enhanced resistance to corrosive cracking and pitting. Cornell has made CD4MCu castings available in-store for 13 of its most popular pump models, which reduces production time. We can now build a CD4MCu pump in about one to two weeks.

CD4MCu BENEFITS

- Corrosion and pitting resistance
- Higher strength than standard grades of stainless steel
- Improved ductility and weldability
- Better resistance to embrittlement

CORNELL PUMP BENEFITS

- Fully automated priming and self-priming, dry-run pumps
- Handles air/liquid mixtures with ease
- Patented Cycloseal®, Redi-Prime®, and Run-Dry™ options
- Cornell Competitive Advantage: Patented Engineering Features

FEATURES

 CLEAN STEEL

 BRINELL HARDNESS
UP TO 285

 INDUSTRY LEADING
TWO YEAR WARRANTY

ADDITIONAL OPTIONS

MOUNTING CONFIGURATIONS

Cornell's modular frame design allows for easy adaptability. Choose a pump and pick the mounting configuration best suited to your application. Right-hand and left-hand rotation, along with tangential or centerline discharges, are available for most pumps.

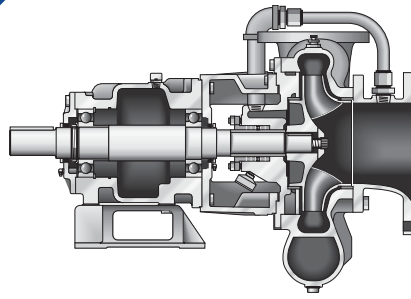

F
HORIZONTAL FRAME MOUNTED

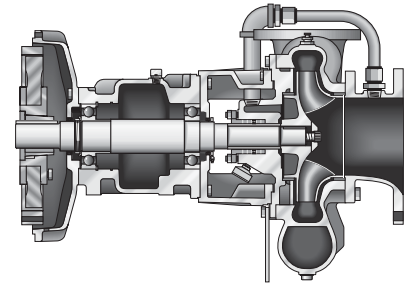

EM
ENGINE MOUNTED

CYCLOSEAL®

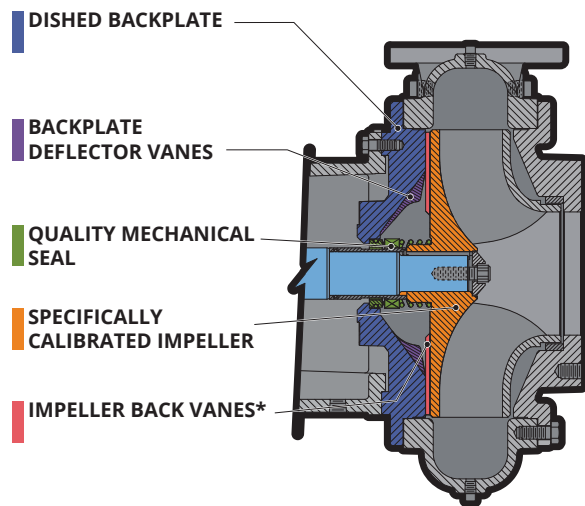

No Flush Water or Packing: Cycloseal eliminates the need for flush water or packing by utilizing the backplate and sweeping vanes, saving on expenses and service time and avoiding messy drips.

Extended Seal Life: Cornell's Cycloseal design has demonstrated its effectiveness in the most demanding applications, often extending the seal life to more than three times the expected lifespan.

System Savings: The Cycloseal system eliminates the need for external water flush, filters, grease cups, or piping typically required for packing or mechanical seals in other pumps. This results in a longer-lasting seal, reducing downtime and lower maintenance costs throughout the pump's lifespan.

Better for Abrasive Applications: Cycloseal is more resilient than packing and standard mechanical seals exposed to abrasives. It prevents solids from reaching the seal area, reducing wear.

Greater Reliability: The positive seating of the Cycloseal system allows end-users to confirm a perfect fit. Its enhanced ability to withstand grit results in longer service intervals.



QUALITY ASSURANCE

Cornell Pump proudly maintains its ISO 9001:2008 certification that validates Cornell complies with all necessary processes to meet customer requirements.

The elements associated with ISO 9001:2015 certification include contract review, design and development, production, purchasing, quality control, and service.

CORNELL PUMP COMPANY

MARKET & PRODUCT LINE

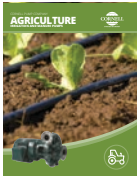

AGRICULTURE



FOOD PROCESS



INDUSTRIAL



MINING

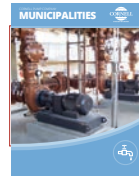

MUNICIPAL



WATER TRANSFER



REFRIGERATION

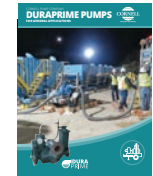

CONSTRUCTION

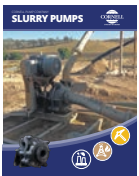

SLURRY

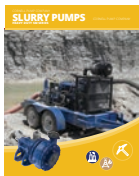

SLURRY SM

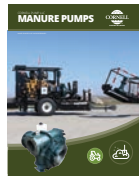

MANURE

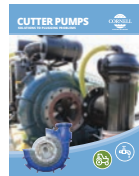

CUTTERS

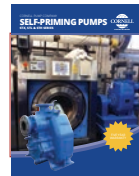

SELF PRIMING

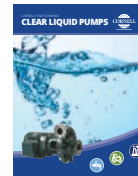

CLEAR LIQUIDS



MX SERIES

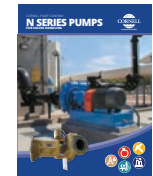

N SERIES

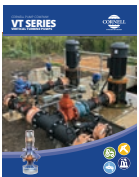

CYCLONE™

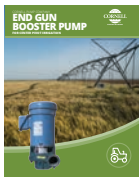

EDGE™



HYDRAULIC SUBS



IMMERSIBLE



CD4MCU



RUN-DRY™



PRIMING SYSTEMS

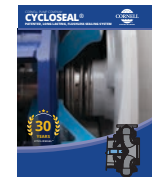

CYCLOSEAL®

Cycloseal® and Redi-Prime® are Registered Trademarks of Cornell Pump Company.

Cornell pumps and products are the subject of one or more of the following U.S. and foreign patents:

6,074,554; 6,036,434; 6,079,958; 6,309,169; 6,104,949.

23 - EV - BR - 401

CORNELLPUMP.COM
©2023 CORNELL PUMP COMPANY



Cornell Pump Company
Clackamas, Oregon, USA
P: +1 (503) 653-0330
F: +1 (503) 653-0338

SOURCE
Bespoke Pumping Solutions



Source Pumps PTY LTD
22 Peterpaul Way
Truganina, VIC 3029
sourcepumps.com.au
sales@sourcepumps.com.au